

PRICE LIST

2023 | 2024

valid from April 1ST, 2023

PRICES | AVAILABILITY OF RANGE
ONLY WITH RANGE IN SHOW ROOM!



Contact our sales office:
Monday - Friday
8:00 am - 6:00 pm
Saturday
10:00 am - 05:00 pm
tel. +49 52 09 / 5 92 246

VENJAKOB
#daslebenaufmöbeln

CARCASE + FRONT:

37- LACQUERED CRYSTAL WHITE MATT



38- LACQUERED ANTHRACITE MATT



ACCENTS IN OPEN SPACES AND BEHIND GLASS DOORS:

03-OAK RUSTICO LIGHT OILED FINISH



72-WILD OAK LIGHT SOFT BRUSHED



No special colours available.

Available finishes for wall units and single items (please add to the order-no.):

CARCASE + FRONT:	WOOD ACCENTS:	5 TH - 8 TH number of the order-no. *
LACQUERED CRYSTAL WHITE MATT	OAK RUSTICO LIGHT OILED FINISH	- 3703_
LACQUERED CRYSTAL WHITE MATT	WILD OAK LIGHT SOFT BRUSHED OILED FINISH	- 3772_
LACQUERED ANTHRACITE MATT	OAK RUSTICO LIGHT OILED FINISH	- 3803_
LACQUERED ANTHRACITE MATT	WILD OAK LIGHT SOFT BRUSHED OILED FINISH	- 3872_

* =
9TH number of the order-no.:
„L“ = item on left / standard model
„R“ = mirrored item

Order-number for items in lacquer finish only:

CARCASE + FRONT:	5 TH - 8 TH number of the order-no. *
LACK KRISTALLWEISS MATT	- 3700_
LACK ANTHRAZIT MATT	- 3800_

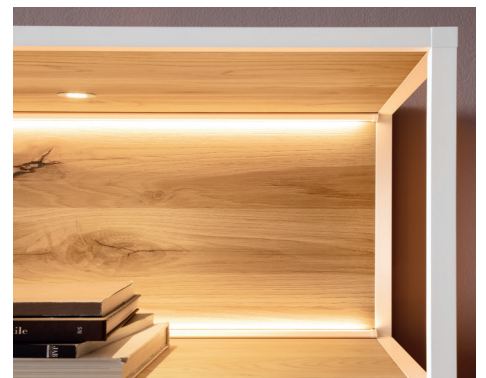

QUALITY FEATURES:

- Carcase and front in 2 lacquer colours: crystal white and anthracite matt.
- Metal frame and handles in colour of the carcase.
- Wood accents in the open spaces and behind glass in the 2 wood colours oak rustico light oiled and wild oak light soft brushed oiled finish.
- LED lighting for an interesting lighting atmosphere for all spaces available.
- All lightings can be operated with Touch-Light.
- Full pull-out drawers.
- High quality fittings with soft-close mechanism.
- Glass doors and glass on side in Optiwhite glass clear.
- Cable flap with plastic cover in the top panel of the lowboards and stacking elements available.
- Special design (special width, height and depth) on request.
- Individual room concepts with the planning programme **furnplan**
- No special colours available.
- 5-Year-Guarantee according to Quality Pass.
- Made in Germany

Summary:								
order no.	description	page	order no.	description	page	order no.	description	page
W030-	hanging lowboard X6	10	W306-	sideboard X6	20	W437-	highboard X6	26
W031-	hanging lowboard X6	10	W308-	sideboard X6	20	W438-	highboard X6	26
W032-	hanging lowboard X6	10	W310-	sideboard X6	20	W439-	highboard X6	26
W033-	hanging lowboard X6	10	W311-	sideboard X6	20	W440-	highboard X6	27
W115-	lowboard X6	11	W312-	sideboard X6	20	W441-	highboard X6	22
W116-	lowboard X6	11	W313-	sideboard X6	21	W442-	highboard X6	24
W117-	lowboard X6	11	W316-	sideboard X6	21	W443-	highboard X6	24
W118-	lowboard X6	11	W318-	sideboard X6	21	W444-	highboard X6	23
W119-	lowboard X6	11	W319-	sideboard X6	21	W445-	highboard X6	25
W120-	lowboard X6	11	W320-	sideboard X6	21	W446-	highboard X6	25
W121-	lowboard X6	11	W321-	sideboard X6	21	W447-	highboard X6	26
W122-	lowboard X6	11	W322-	sideboard X6	21	W600-	cabinet X6	28
W123-	lowboard X6	11	W400-	highboard X6	22	W601-	cabinet X6	28
W124-	lowboard X6	12	W401-	highboard X6	22	W602-	cabinet X6	28
W125-	lowboard X6	12	W402-	highboard X6	22	W603-	cabinet X6	28
W130-	lowboard X6	13	W403-	highboard X6	22	W604-	cabinet X6	28
W131-	lowboard X6	13	W404-	highboard X6	22	W605-	cabinet recommendation X6	28
W132-	lowboard X6	13	W405-	highboard X6	22	W606-	cabinet recommendation X6	28
W133-	lowboard X6	13	W406-	highboard X6	22	W607-	cabinet recommendation X6	28
W134-	lowboard X6	13	W407-	highboard X6	22	W608-	cabinet recommendation X6	28
W135-	lowboard X6	13	W408-	highboard X6	23	W720-	wall panel with trays X6	18
W136-	lowboard X6	13	W409-	highboard X6	23	W730-	hanging cabinet X6	19
W137-	lowboard X6	13	W410-	highboard X6	23	W731-	hanging cabinet X6	19
W138-	lowboard X6	13	W411-	highboard X6	23	W732-	hanging cabinet X6	19
W139-	lowboard X6	14	W412-	highboard X6	23	W733-	hanging cabinet X6	19
W140-	lowboard X6	14	W415-	highboard X6	23	W734-	hanging cabinet X6	19
W141-	lowboard X6	14	W416-	highboard X6	23	W735-	hanging cabinet X6	19
W142-	lowboard X6	14	W417-	highboard X6	23	W736-	hanging cabinet X6	19
W143-	lowboard X6	14	W418-	highboard X6	24	W737-	hanging cabinet X6	19
W144-	lowboard X6	14	W419-	highboard X6	24	W840-	cable outlet in top panel X6	29
W145-	lowboard X6	14	W420-	highboard X6	24	W841-	cable outlet in stacking unit X6	29
W146-	lowboard X6	14	W421-	highboard X6	24	W847-	cutlery insert X6	29
W147-	lowboard X6	14	W422-	highboard X6	24	W890-	wood shelf X6 (additional)	29
W148-	lowboard X6	15	W423-	highboard X6	24	W891-	wood shelf X6 (additional)	29
W149-	lowboard X6	15	W424-	highboard X6	24	W892-	wood shelf X6 (additional)	29
W150-	lowboard X6	15	W425-	highboard X6	25	W901-	LED lighting X6 for space	29
W200-	hanging sideboard X6	16	W426-	highboard X6	25	W902-	LED rear panel lighting X6	29
W202-	hanging sideboard X6	16	W427-	highboard X6	25	W915-	transformer X6	29
W203-	hanging sideboard X6	16	W428-	highboard X6	25	W916-	Extra extension cord X6	29
W210-	sideboard X6	17	W429-	highboard X6	25	0094-	transmit dimmer set	29
W211-	sideboard X6	17	W430-	highboard X6	25			
W212-	sideboard X6	17	W431-	highboard X6	25			
W213-	sideboard X6	17	W432-	highboard X6	26			
W300-	sideboard X6	20	W433-	highboard X6	26			
W302-	sideboard X6	20	W434-	highboard X6	26			
W304-	sideboard X6	20	W435-	highboard X6	26			
W305-	sideboard X6	20	W436-	highboard X6	26			

Important notice:

The supplied fastening material (dowels and screws) is intended only for assembly of components to concrete or solid masonry walls. When assembling components to a wall please always adhere to the max. load values. The nature of the designated wall is ideally enquired during the order process and checked again before assembly by the assembly technicians. If the structure of the wall is deviating from solid structure (e.g. lightweight walls) a different, suitable attachment method is imperative. Clarify all electrical conditions for connection and device technology upfront. Freely hanging lightings need a solution with a duct channel on or below plaster.

Finishes:

Please add the 5TH - 8TH number of the order-no. for the finish code.

(see overview page 2)

9TH number of the order-no.: L=pictured wall unit | R=mirrored wall unit

RECOMMENDATION X601-....L/R

R = reversed (same price)

W 283 cm
H 189 cm
D 53/33 cm

TOTAL PRICE

recommendation consists of:

1x lowboard X6	W123-....L
1x hanging cabinet X6	W732-....R

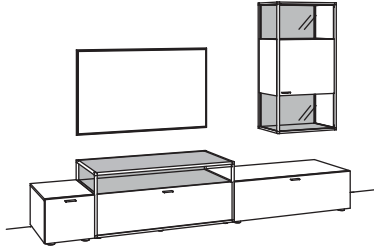

LIGHTING PACKAGE:

complete lighting incl. transformer, extension cord and dimmer **WL01-0000**

LIGHTING for single orders

4x set of 1 LED lighting, lowboard/hanging cabinet à	W901-0001
1x rear panel lighting, lowboard	W902-0011
1x rear panel lighting, hanging cabinet	W902-0004
2x transformer à	W915-0000
1x transmit dimmer set	0094-0043

supplementary equipment, optional:

1x cable outlet, lowboard	W840-0000
1x cable outlet in stacking unit, lowboard	W841-0000

RECOMMENDATION X602-....L/R

R = reversed (same price)

W 330 cm
H 189 cm
D 53/33 cm

TOTAL PRICE

recommendation consists of:

1x lowboard X6	W123-....L
1x hanging cabinet X6	W736-....

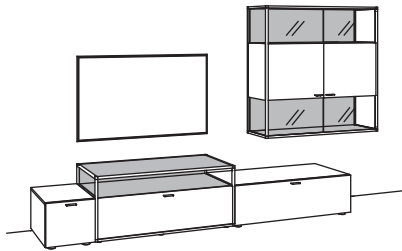

LIGHTING PACKAGE:

complete lighting incl. transformer, extension cord and dimmer **WL02-0000**

LIGHTING for single orders

6x set of 1 LED lighting, lowboard/hanging cabinet à	W901-0001
1x rear panel lighting, lowboard	W902-0011
1x rear panel lighting, hanging cabinet	W902-0014
3x transformer à	W915-0000
1x transmit dimmer set	0094-0043

supplementary equipment, optional:

1x cable outlet, lowboard	W840-0000
1x cable outlet in stacking unit, lowboard	W841-0000

RECOMMENDATION X603-....L/R

R = reversed (same price)

W 303 cm
H 206 cm
D 53/33 cm

TOTAL PRICE

recommendation consists of:

1x lowboard X6	W150-....L
1x hanging cabinet X6	W731-....R

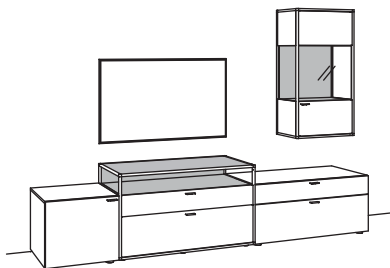

LIGHTING PACKAGE:

complete lighting incl. transformer, extension cord and dimmer **WL03-0000**

LIGHTING for single orders

3x set of 1 LED lighting, lowboard/hanging cabinet à	W901-0001
1x rear panel lighting, lowboard	W902-0011
1x rear panel lighting, hanging cabinet	W902-0002
2x transformer à	W915-0000
1x additional extension cord	W916-0000
1x transmit dimmer set	0094-0043

supplementary equipment, optional:

1x cable outlet, lowboard	W840-0000
1x cable outlet in stacking unit, lowboard	W841-0000

Finishes:

Please add the 5TH - 8TH number of the order-no. for the finish code.

(see overview page 2)

9TH number of the order-no.: L=pictured wall unit | R=mirrored wall unit

RECOMMENDATION X604-....L/R

R = reversed (same price)

W 303 cm
H 189 cm
D 53/28 cm

TOTAL PRICE

recommendation consists of:

1x lowboard X6	W147-....L
1x wall panel with trays X6	W720-....

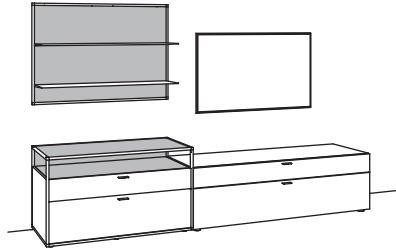

supplementary equipment, optional:

complete lighting incl. transformer, extension cord and dimmer	WL04-0000
--	------------------

LIGHTING for single orders

2x set of 1 LED lighting, lowboard à	W901-0001
1x rear panel lighting, lowboard	W902-0011
1x rear panel lighting, bridging shelf	W902-0012
2x transformer à	W915-0000
1x transmit dimmer set	0094-0043

supplementary equipment, optional:

1x cable outlet, lowboard	W840-0000
1x cable outlet in stacking unit, lowboard	W841-0000

Wall panel always in wood finish with metal shelves in colour of the carcass.

RECOMMENDATION X605-....L/R

R = reversed (same price)

W 330 cm
H 189 cm
D 53/28 cm

TOTAL PRICE

recommendation consists of:

1x lowboard X6	W144-....L
1x wall panel with trays X6	W720-....

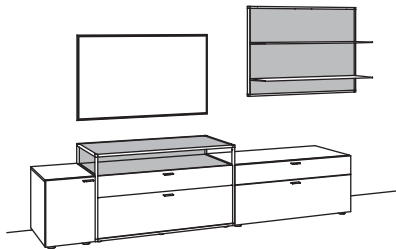

LIGHTING PACKAGE:

complete lighting incl. transformer, extension cord and dimmer	WL05-0000
--	------------------

LIGHTING for single orders

2x set of 1 LED lighting, lowboard à	W901-0001
1x rear panel lighting, lowboard	W902-0011
1x rear panel lighting, bridging shelf	W902-0012
2x transformer à	W915-0000
1x transmit dimmer set	0094-0043

supplementary equipment, optional:

1x cable outlet, lowboard	W840-0000
1x cable outlet in stacking unit, lowboard	W841-0000

Wall panel always in wood finish with metal shelves in colour of the carcass.

RECOMMENDATION X606-....L/R

R = reversed (same price)

W 285 cm
H 206 cm
D 53/33 cm

TOTAL PRICE

recommendation consists of:

1x lowboard X6	W140-....
1x hanging cabinet X6	W732-....R

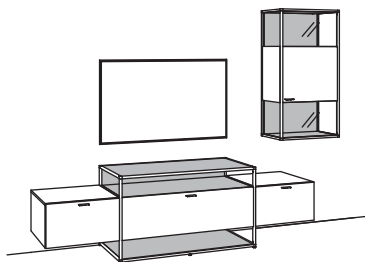

LIGHTING PACKAGE:

complete lighting incl. transformer, extension cord and dimmer	WL06-0000
--	------------------

LIGHTING for single orders

6x set of 1 LED lighting, lowboard/hanging cabinet à	W901-0001
1x rear panel lighting, lowboard	W902-0012
1x rear panel lighting, hanging cabinet	W902-0004
2x transformer à	W915-0000
1x transmit dimmer set	0094-0043

supplementary equipment, optional:

1x cable outlet, lowboard	W840-0000
1x cable outlet in stacking unit, lowboard	W841-0000

Finishes:

Please add the 5TH - 8TH number of the order-no. for the finish code.

(see overview page 2)

9TH number of the order-no.: L=pictured wall unit | R=mirrored wall unit

RECOMMENDATION X607-....L/R

R = reversed (same price)

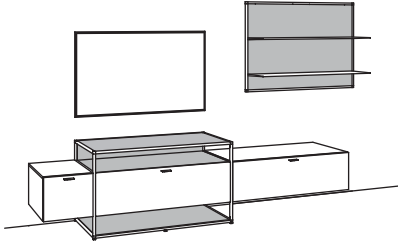

W 330 cm
H 189 cm
D 53/28 cm

TOTAL PRICE

recommendation consists of:

1x lowboard X6	W143-....L
1x wall panel with trays X6	W720-....

LIGHTING PACKAGE:

complete lighting incl. transformer, extension cord and dimmer **WL07-0000**

LIGHTING for single orders

4x set of 1 LED lighting, lowboard à	W901-0001
1x rear panel lighting, lowboard	W902-0012
1x rear panel lighting, bridging shelf	W902-0012
2x transformer à	W915-0000
1x transmit dimmer set	0094-0043

supplementary equipment, optional:

1x cable outlet, lowboard	W840-0000
1x cable outlet in stacking unit, lowboard	W841-0000

Wall panel always in wood finish with metal shelves in colour of the carcass.

RECOMMENDATION X608-....L/R

R = reversed (same price)

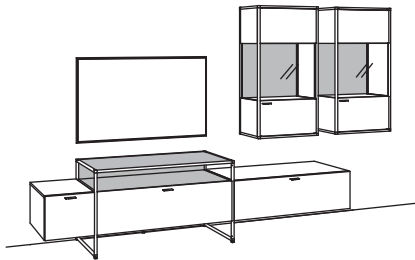

W 346 cm
H 206 cm
D 53/33 cm

TOTAL PRICE

recommendation consists of:

1x lowboard X6	W142-....L
2x hanging cabinet X6	W731-....R

LIGHTING PACKAGE:

complete lighting incl. transformer, extension cord and dimmer **WL08-0000**

LIGHTING for single orders

4x set of 1 LED lighting, lowboard/hanging cabinet à	W901-0001
1x rear panel lighting, lowboard	W902-0011
2x rear panel lighting, hanging cabinet à	W902-0002
3x transformer à	W915-0000
1x transmit dimmer set	0094-0043

supplementary equipment, optional:

1x cable outlet, lowboard	W840-0000
1x cable outlet in stacking unit, lowboard	W841-0000

RECOMMENDATION X609-....L/R

R = reversed (same price)

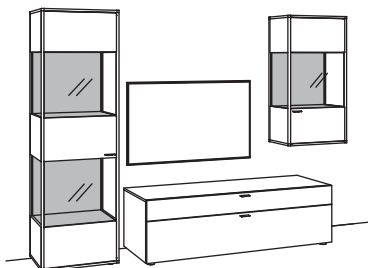

W 295 cm
H 206 cm
D 53/43/33 cm

TOTAL PRICE

recommendation consists of:

1x cabinet X6	W601-....L
1x lowboard X6	W116-..00
1x hanging cabinet X6	W731-....R

supplementary equipment, optional:

complete lighting incl. transformer, extension cord and dimmer **WL09-0000**

LIGHTING for single orders

3x set of 1 LED lighting, cabinet/hanging cabinet à	W901-0001
1x rear panel lighting, cabinet	W902-0004
1x rear panel lighting, hanging cabinet	W902-0002
2x transformer à	W915-0000
1x additional extension cord	W916-0000
1x transmit dimmer set	0094-0043

supplementary equipment, optional:

1x cable outlet, lowboard	W840-0000
---------------------------	-----------

Finishes:

Please add the 5TH - 8TH number of the order-no. for the finish code.

(see overview page 2)

9TH number of the order-no.: L=pictured wall unit | R=mirrored wall unit

RECOMMENDATION X610-....L/R

R = reversed (same price)

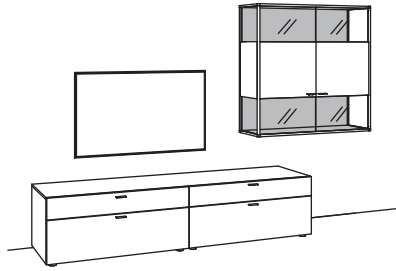

W 320 cm
H 206 cm
D 53/33 cm

TOTAL PRICE

recommendation consists of:

1x lowboard X6	W120-...00L
1x hanging cabinet X6	W736-....

LIGHTING PACKAGE:

complete lighting incl. transformer, extension cord and dimmer **WL10-0000**

LIGHTING for single orders

4x set of 1 LED lighting, hanging cabinet à	W901-0001
1x rear panel lighting, hanging cabinet	W902-0014
2x transformer à	W915-0000
1x transmit dimmer set	0094-0043

supplementary equipment, optional:

1x cable outlet, lowboard	W840-0000
---------------------------	-----------

RECOMMENDATION X611-....L/R

R = reversed (same price)

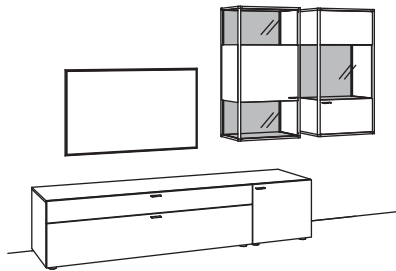

W 325 cm
H 206 cm
D 53/33 cm

TOTAL PRICE

recommendation consists of:

1x lowboard X6	W119-...00R
1x hanging cabinet X6	W732-....L
1x hanging cabinet X6	W731-....R

LIGHTING PACKAGE:

complete lighting incl. transformer, extension cord and dimmer **WL11-0000**

LIGHTING for single orders

3x set of 1 LED lighting, hanging cabinet à	W901-0001
1x rear panel lighting, hanging cabinet	W902-0004
1x rear panel lighting, hanging cabinet	W902-0002
2x transformer à	W915-0000
1x transmit dimmer set	0094-0043

supplementary equipment, optional:

1x cable outlet, lowboard	W840-0000
---------------------------	-----------

RECOMMENDATION X612-....L/R

R = reversed (same price)

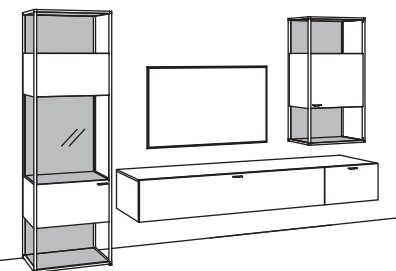

W 325 cm
H 205 cm
D 53/43/33 cm

TOTAL PRICE

recommendation consists of:

1x cabinet X6	W602-....L
1x hanging lowboard X6	W032-...00R
1x hanging cabinet X6	W733-....R

LIGHTING PACKAGE:

complete lighting incl. transformer, extension cord and dimmer **WL12-0000**

LIGHTING for single orders

5x set of 1 LED lighting, cabinet/hanging cabinet à	W901-0001
1x rear panel lighting, cabinet	W902-0006
1x rear panel lighting, hanging cabinet	W902-0004
3x transformer à	W915-0000
1x transmit dimmer set	0094-0043

supplementary equipment, optional:

1x cable outlet, hanging lowboard	W840-0000
-----------------------------------	-----------

Finishes:

Please add the 5TH - 8TH number of the order-no. for the finish code.

(see overview page 2)

9TH number of the order-no.: L=pictured wall unit | R=mirrored wall unit

RECOMMENDATION X613-....L/R

R = reversed (same price)

W 303 cm
H 205 cm
D 43 cm

TOTAL PRICE

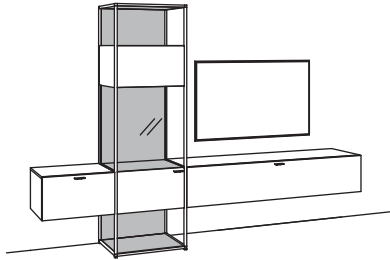

recommendation consists of:

1x cabinet recommendation X6 W608-....L

LIGHTING PACKAGE:

complete lighting incl. transformer, extension cord and dimmer **WL13-0000**

LIGHTING for single orders

3x	set of 1 LED lighting, cabinet recommendation à	W901-0001
1x	rear panel lighting, cabinet recommendation	W902-0006
2x	transformer à	W915-0000
1x	transmit dimmer set	0094-0043

supplementary equipment, optional:

1x	cable outlet	W840-0000
----	--------------	-----------

RECOMMENDATION X614-....L/R

R = reversed (same price)

W 303 cm
H 206 cm
D 43 cm

TOTAL PRICE

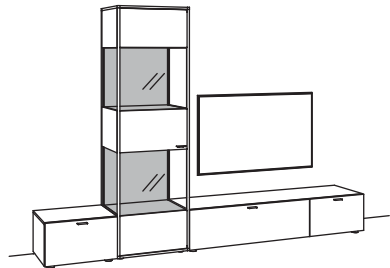

recommendation consists of:

1x cabinet recommendation X6 W607-....L

LIGHTING PACKAGE:

complete lighting incl. transformer, extension cord and dimmer **WL14-0000**

LIGHTING for single orders

2x	set of 1 LED lighting, cabinet recommendation à	W901-0001
1x	rear panel lighting, cabinet recommendation	W902-0004
1x	transformer	W915-0000
1x	transmit dimmer set	0094-0043

supplementary equipment, optional:

1x	cable outlet	W840-0000
----	--------------	-----------

RECOMMENDATION X615-....L/R

R = reversed (same price)

W 241 cm
H 189 cm
D 43/28 cm

TOTAL PRICE

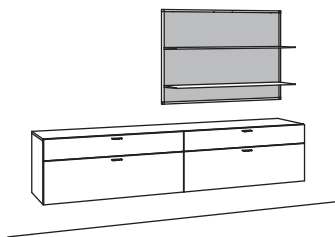

recommendation consists of:

1x	hanging sideboard X6	W203-..00L
1x	wall panel with trays X6	W720-....

supplementary equipment, optional:

complete lighting incl. transformer, extension cord and dimmer **WL15-0000**

LIGHTING for single orders

1x	rear panel lighting, bridging shelf	W902-0012
1x	transformer	W915-0000
1x	transmit dimmer set	0094-0043

Wall panel always in wood finish with metal shelves in colour of the carcass.

Finishes:

Please add the 5TH - 8TH number of the order-no. for the finish code.

(see overview page 2)

9TH number of the order-no.: L=pictured wall unit | R=mirrored wall unit

RECOMMENDATION X616-....L/R

R = reversed (same price)

W 243 cm
H 205 cm
D 43 cm

TOTAL PRICE

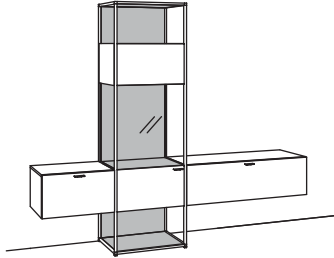

recommendation consists of:

1x cabinet recommendation X6 W606-....L

LIGHTING PACKAGE:

complete lighting incl. transformer, extension cord and dimmer **WL16-0000**

LIGHTING for single orders

3x	set of 1 LED lighting, cabinet recommendation à	W901-0001
1x	rear panel lighting, cabinet recommendation	W902-0006
2x	transformer à	W915-0000
1x	transmit dimmer set	0094-0043

supplementary equipment, optional:

1x	cable outlet	W840-0000
----	--------------	-----------

RECOMMENDATION X618-....L/R

R = reversed (same price)

W 320 cm
H 189 cm
D 43/28 cm

TOTAL PRICE

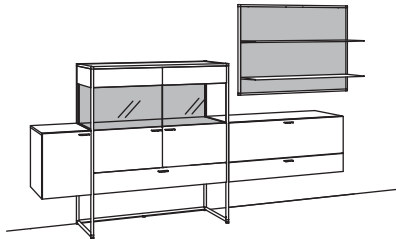

recommendation consists of:

1x highboard X6 W431-....L
1x wall panel with trays X6 W720-....

LIGHTING PACKAGE:

complete lighting incl. transformer, extension cord and dimmer **WL18-0000**

LIGHTING for single orders

2x	set of 1 LED lighting, highboard à	W901-0001
1x	rear panel lighting, highboard	W902-0012
1x	rear panel lighting, bridging shelf	W902-0012
2x	transformer à	W915-0000
1x	transmit dimmer set	0094-0043

Wall panel always in wood finish with metal shelves in colour of the carcass.

Finishes:

Please add the 5TH - 8TH number of the order-no. for the finish code.
(see overview page 2)

1 GRID H 34 cm **HANGING LOWBOARD**

HANGING LOWBOARD X6

1 drop flap
(space divided) W à 180 cm
1 full pull out drawer H 34 cm
max. load up to 40 kg D 53 cm
assembled

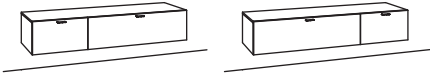

order no.:	W030-..00L/R	à
lacquerd		
cable outlet	W840-0000	

HANGING LOWBOARD X6

1 drop flap W 180 cm
(space tri-parted) H 34 cm
max. load up to 40 kg D 53 cm
assembled



order no.:	W031-..00	
lacquerd		
cable outlet	W840-0000	

HANGING LOWBOARD X6

1 drop flap W à 240 cm
(space tri-parted) H 34 cm
1 full pull out drawer D 53 cm
max. load up to 40 kg
pre-assembled, 3 cases

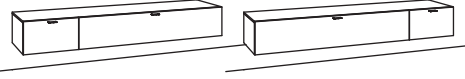

order no.:	W032-..00L/R	à
lacquerd		
cable outlet	W840-0000	

HANGING LOWBOARD X6

1 drop flap W à 240 cm
(space divided) H 34 cm
1 full pull out drawer D 53 cm
(divided)
max. load up to 40 kg
pre-assembled, 3 cases

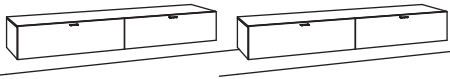

order no.:	W033-..00L/R	à
lacquerd		
cable outlet	W840-0000	

1,5 GRIDS

H 53 cm

LOWBOARD

LOWBOARD X6

- 1 door
- 1 wood shelf, adjustable
- 1 full pull out drawer, on top (divided)
- 1 drop flap (space divided) assembled

W à 180 cm
H 53 cm
D 53 cm

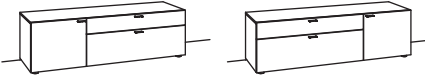

LHF RHF

order no.: **W115-..00L/R**

lacquerd

W840-0000

LOWBOARD X6

- 1 full pull out drawer, on top (tri-parted)
- 1 drop flap (space tri-parted) assembled

W 180 cm
H 53 cm
D 53 cm

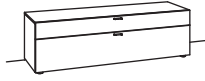

order no.: **W116-..00**

lacquerd

W840-0000

LOWBOARD X6

- 1 drop flap (space divided)
- 1 full pull out drawer
- 1 open space
- pre-assembled, 2 cases

W à 183 cm
H 53 cm
D 53 cm

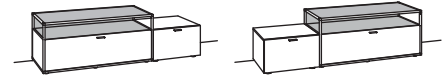

order no.: **W117-....L/R**

- 2x set of 1 LED lighting W901-0001 à
- rear panel lighting W902-0011
- transformer W915-0000
- cable outlet in stacking unit W841-0000
- cable outlet W840-0000

LOWBOARD X6

- 2 full pull out drawers
- 1 drop flap (space divided)
- 1 open space
- pre-assembled, 3 cases

W à 223 cm
H 53 cm
D 53 cm

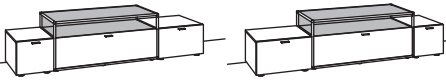

order no.: **W118-....L/R**

- 2x set of 1 LED lighting W901-0001 à
- rear panel lighting W902-0011
- transformer W915-0000
- cable outlet in stacking unit W841-0000
- cable outlet W840-0000

LOWBOARD X6

- 1 door
- 1 wood shelf, adjustable
- 1 full pull out drawer, on top (tri-parted)
- 1 drop flap (space tri-parted) pre-assembled, 3 cases

W à 240 cm
H 53 cm
D 53 cm

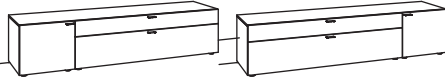

LHF RHF

order no.: **W119-..00L/R**

lacquerd

W840-0000

LOWBOARD X6

- 3 full pull out drawers (divided)
- 1 drop flap below (space divided)
- pre-assembled, 3 cases

W à 240 cm
H 53 cm
D 53 cm

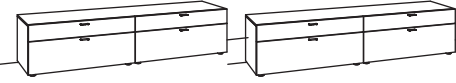

order no.: **W120-..00L/R**

- lacquerd
- cable outlet W840-0000

LOWBOARD X6

- 1 drop flap (space divided)
- 1 full pull out drawer (divided)
- 1 open space
- pre-assembled, 2 cases

W à 243 cm
H 53 cm
D 53 cm

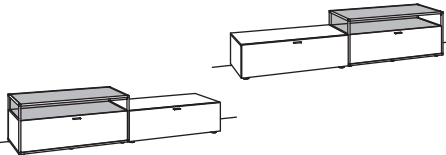

order no.: **W121-....L/R**

- 2x set of 1 LED lighting W901-0001 à
- rear panel lighting W902-0011
- transformer W915-0000
- cable outlet in stacking unit W841-0000
- cable outlet W840-0000

LOWBOARD X6

- 2 full pull out drawers
- 1 drop flap centre (space divided)
- 1 open space
- pre-assembled, 3 cases

W 243 cm
H 53 cm
D 53 cm

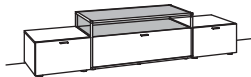

order no.: **W122-....**

- 2x set of 1 LED lighting W901-0001 à
- rear panel lighting W902-0011
- transformer W915-0000
- cable outlet in stacking unit W841-0000
- cable outlet W840-0000

LOWBOARD X6

- 2 full pull out drawers (the large drawer is divided)
- 1 drop flap centre (space divided)
- 1 open space
- pre-assembled, 3 cases

W à 283 cm
H 53 cm
D 53 cm

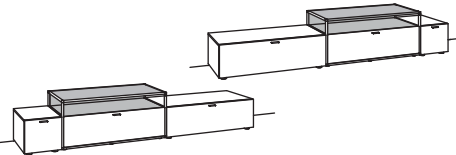

order no.: **W123-....L/R**

- 2x set of 1 LED lighting W901-0001 à
- rear panel lighting W902-0011
- transformer W915-0000
- cable outlet in stacking unit W841-0000
- cable outlet W840-0000

Finishes:

Please add the 5TH - 8TH number of the order-no. for the finish code.
(see overview page 2)

LOWBOARD X6

1 drop flap
(space divided)
1 full pull out drawer
(tri-parted)
1 open space
pre-assembled, 2 cases

W à 303 cm
H 53 cm
D 53 cm

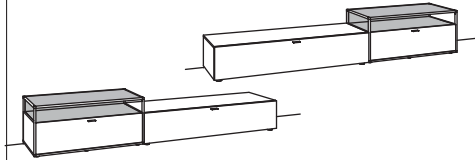

order no.: **W124-....L/R**

à

2x set of 1 LED lighting	W901-0001	à
rear panel lighting	W902-0011	
transformer	W915-0000	
cable outlet in stacking unit	W841-0000	
cable outlet	W840-0000	

LOWBOARD X6

2 full pull out drawers
(the large drawer is
divided)
1 drop flap centre (space divided)
1 open space
pre-assembled, 3 cases

W à 303 cm
H 53 cm
D 53 cm

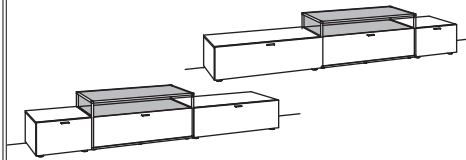

order no.: **W125-....L/R**

à

2x set of 1 LED lighting	W901-0001	à
rear panel lighting	W902-0011	
transformer	W915-0000	
cable outlet in stacking unit	W841-0000	
cable outlet	W840-0000	

LOWBOARD X6

1 drop flap
(space divided)
1 full pull out drawer
1 open space
pre-assembled, 2 cases

W à 183 cm
H 69 cm
D 53 cm

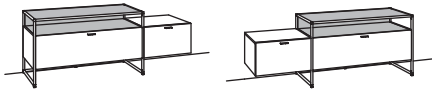

order no.: **W130-....L/R**

à

2x set of 1 LED lighting	W901-0001	à
rear panel lighting	W902-0011	
transformer	W915-0000	
cable outlet in stacking unit	W841-0000	
cable outlet	W840-0000	

LOWBOARD X6

1 drop flap
(space divided)
1 full pull out drawer
2 open spaces
pre-assembled, 2 cases

W à 183 cm
H 69 cm
D 53 cm

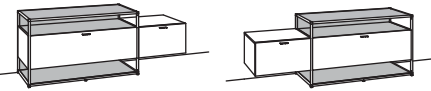

order no.: **W131-....L/R**

à

4x set of 1 LED lighting	W901-0001	à
rear panel lighting	W902-0012	
transformer	W915-0000	
cable outlet in stacking unit	W841-0000	
cable outlet	W840-0000	

LOWBOARD X6

1 door
1 wood shelf, adjustable
1 full pull out drawer,
on top (divided)
1 drop flap (space divided)
1 open space
pre-assembled, 2 cases

W à 183 cm
H 70 cm
D 53 cm

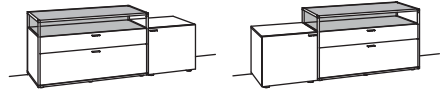

RHF LHF

order no.: **W132-....L/R**

à

2x set of 1 LED lighting	W901-0001	à
rear panel lighting	W902-0011	
transformer	W915-0000	
cable outlet in stacking unit	W841-0000	
cable outlet	W840-0000	

LOWBOARD X6

2 full pull out drawers
1 drop flap centre
(space divided)
1 open space
pre-assembled, 3 cases

W à 223 cm
H 69 cm
D 53 cm

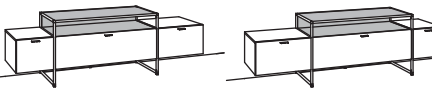

order no.: **W133-....L/R**

à

2x set of 1 LED lighting	W901-0001	à
rear panel lighting	W902-0011	
transformer	W915-0000	
cable outlet in stacking unit	W841-0000	
cable outlet	W840-0000	

LOWBOARD X6

2 full pull out drawers
1 drop flap centre
(space divided)
2 open spaces
pre-assembled, 3 cases

W à 223 cm
H 69 cm
D 53 cm

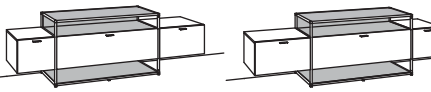

order no.: **W134-....L/R**

à

4x set of 1 LED lighting	W901-0001	à
rear panel lighting	W902-0012	
transformer	W915-0000	
cable outlet in stacking unit	W841-0000	
cable outlet	W840-0000	

LOWBOARD X6

1 door
1 wood shelf, adjustable
3 full pull out drawers
(the large drawer is
divided)
1 drop flap below (space divided)
1 open space
pre-assembled, 3 cases

W à 223 cm
H 70 cm
D 53 cm

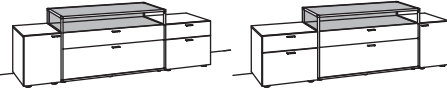

LHF RHF

order no.: **W135-....L/R**

à

2x set of 1 LED lighting	W901-0001	à
rear panel lighting	W902-0011	
transformer	W915-0000	
cable outlet in stacking unit	W841-0000	
cable outlet	W840-0000	

LOWBOARD X6

1 drop flap
(space divided)
1 full pull out drawer
(divided)
1 open space
pre-assembled, 2 cases

W à 243 cm
H 69 cm
D 53 cm

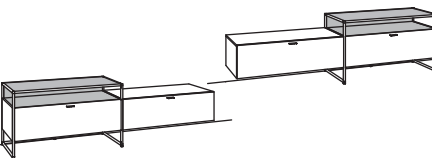

order no.: **W136-....L/R**

à

2x set of 1 LED lighting	W901-0001	à
rear panel lighting	W902-0011	
transformer	W915-0000	
cable outlet in stacking unit	W841-0000	
cable outlet	W840-0000	

LOWBOARD X6

1 drop flap
(space divided)
1 full pull out drawer
(divided)
2 open spaces
pre-assembled, 2 cases

W à 243 cm
H 69 cm
D 53 cm

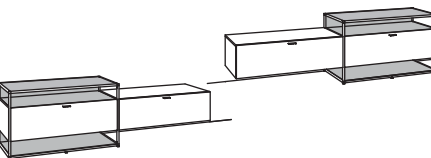

order no.: **W137-....L/R**

à

4x set of 1 LED lighting	W901-0001	à
rear panel lighting	W902-0012	
transformer	W915-0000	
cable outlet in stacking unit	W841-0000	
cable outlet	W840-0000	

LOWBOARD X6

3 full pull out drawers
(divided)
1 drop flap (space divided)
1 open space
pre-assembled, 2 cases

W à 243 cm
H 70 cm
D 53 cm

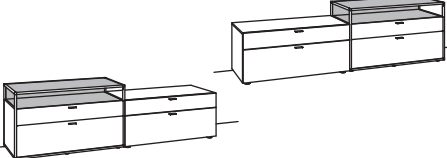

order no.: **W138-....L/R**

à

2x set of 1 LED lighting	W901-0001	à
rear panel lighting	W902-0011	
transformer	W915-0000	
cable outlet in stacking unit	W841-0000	
cable outlet	W840-0000	

2 GRIDS H 69/70 cm **LOWBOARD**

LOWBOARD X6		LOWBOARD X6		LOWBOARD X6	
2 full pull out drawers 1 drop flap centre (space divided) 1 open space pre-assembled, 3 cases	W 243 cm H 69 cm D 53 cm	2 full pull out drawers 1 drop flap centre (space divided) 2 open spaces pre-assembled, 3 cases	W 243 cm H 69 cm D 53 cm	2 doors 2 wood shelves, adjustable 1 full pull out drawer, on top (divided) 1 drop flap (space divided) 1 open space pre-assembled, 3 cases	W 243 cm H 70 cm D 53 cm
order no.: W139-....		order no.: W140-....		order no.: W141-....	
2x set of 1 LED lighting	W901-0001 à	4x set of 1 LED lighting	W901-0001 à	2x set of 1 LED lighting	W901-0001 à
rear panel lighting	W902-0011	rear panel lighting	W902-0012	rear panel lighting	W902-0011
transformer	W915-0000	transformer	W915-0000	transformer	W915-0000
cable outlet in stacking unit	W841-0000	cable outlet in stacking unit	W841-0000	cable outlet in stacking unit	W841-0000
cable outlet	W840-0000	cable outlet	W840-0000	cable outlet	W840-0000

LOWBOARD X6		LOWBOARD X6		LOWBOARD X6	
2 full pull out drawers (the large drawer is divided) 1 drop flap centre (space divided) 1 open space pre-assembled, 3 cases	W à 283 cm H 69 cm D 53 cm	2 full pull out drawers (the large drawer is divided) 1 drop flap centre (space divided) 2 open spaces pre-assembled, 3 cases	W à 283 cm H 69 cm D 53 cm	1 door 1 wood shelf, adjustable 3 full pull out drawers (divided) 1 drop flap below centre (space divided) 1 open space pre-assembled, 3 cases	W à 283 cm H 70 cm D 53 cm
order no.: W142-....L/R	à	order no.: W143-....L/R	à	order no.: W144-....L/R	à
2x set of 1 LED lighting	W901-0001 à	4x set of 1 LED lighting	W901-0001 à	2x set of 1 LED lighting	W901-0001 à
rear panel lighting	W902-0011	rear panel lighting	W902-0012	rear panel lighting	W902-0011
transformer	W915-0000	transformer	W915-0000	transformer	W915-0000
cable outlet in stacking unit	W841-0000	cable outlet in stacking unit	W841-0000	cable outlet in stacking unit	W841-0000
cable outlet	W840-0000	cable outlet	W840-0000	cable outlet	W840-0000

LOWBOARD X6		LOWBOARD X6		LOWBOARD X6	
1 drop flap (space divided) 1 full pull out drawer (tri-parted) 1 open space pre-assembled, 2 cases	W à 303 cm H 69 cm D 53 cm	1 drop flap (space divided) 1 full pull out drawer (tri-parted) 2 open spaces pre-assembled, 2 cases	W à 303 cm H 69 cm D 53 cm	3 full pull out drawers (davon 2 drawer tri-parted, 1 drawer divided) 1 drop flap below (space divided) 1 open space pre-assembled, 2 cases	W à 303 cm H 70 cm D 53 cm
order no.: W145-....L/R	à	order no.: W146-....L/R	à	order no.: W147-....L/R	à
2x set of 1 LED lighting	W901-0001 à	4x set of 1 LED lighting	W901-0001 à	2x set of 1 LED lighting	W901-0001 à
rear panel lighting	W902-0011	rear panel lighting	W902-0012	rear panel lighting	W902-0011
transformer	W915-0000	transformer	W915-0000	transformer	W915-0000
cable outlet in stacking unit	W841-0000	cable outlet in stacking unit	W841-0000	cable outlet in stacking unit	W841-0000
cable outlet	W840-0000	cable outlet	W840-0000	cable outlet	W840-0000

Finishes:

Please add the 5TH - 8TH number of the order-no. for the finish code.
(see overview page 2)

2 GRIDS

H 69/70 cm

LOWBOARD

LOWBOARD X6

2 full pull out drawers
(the large drawer is divided)
1 drop flap centre
(space divided)
1 open space
pre-assembled, 3 cases

W à 303 cm
H 69 cm
D 53 cm

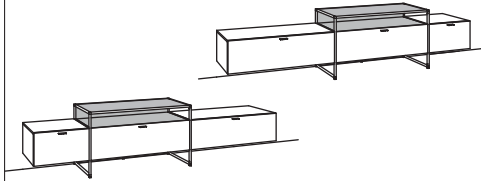

order no.: **W148-....L/R**

2x set of 1 LED lighting	W901-0001	à
rear panel lighting	W902-0011	
transformer	W915-0000	
cable outlet in stacking unit	W841-0000	
cable outlet	W840-0000	

LOWBOARD X6

2 full pull out drawers
(the large drawer is divided)
1 drop flap centre
(space divided)
2 open spaces
pre-assembled, 3 cases

W à 303 cm
H 69 cm
D 53 cm

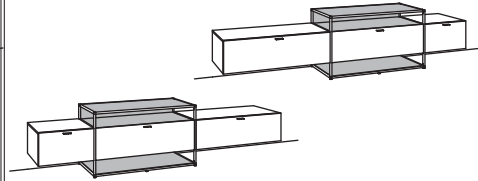

order no.: **W149-....L/R**

4x set of 1 LED lighting	W901-0001	à
rear panel lighting	W902-0012	
transformer	W915-0000	
cable outlet in stacking unit	W841-0000	
cable outlet	W840-0000	

LOWBOARD X6

1 door
1 wood shelf, adjustable
3 full pull out drawers
(divided)
1 drop flap below centre
(space divided)
1 open space
pre-assembled, 3 cases

W à 303 cm
H 70 cm
D 53 cm

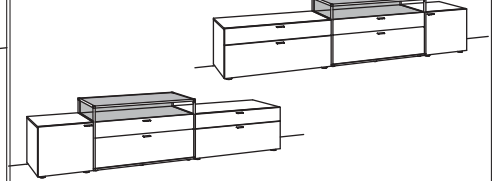

order no.: **W150-....L/R**

2x set of 1 LED lighting	W901-0001	à
rear panel lighting	W902-0011	
transformer	W915-0000	
cable outlet in stacking unit	W841-0000	
cable outlet	W840-0000	



Finishes:

Please add the 5TH - 8TH number of the order-no. for the finish code.
(see overview page 2)

1,5 GRIDS

H 51 cm

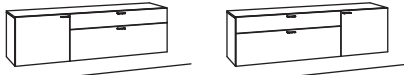
HANGING SIDEBOARD

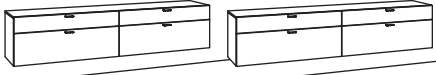
HANGING SIDEBOARD X6		HANGING SIDEBOARD X6		HANGING SIDEBOARD X6	
<p>1 door 1 wood shelf, adjustable 1 full pull out drawer, on top (divided) 1 drop flap (space divided) max. load up to 40 kg assembled</p>	<p>W à 180 cm H 51 cm D 43 cm</p>	<p>2 doors 2 wood shelves, adjustable 1 full pull out drawer, on top (divided) 1 drop flap (space divided) max. load up to 60 kg pre-assembled, 4 cases</p>	<p>W 240 cm H 51 cm D 43 cm</p>	<p>3 full pull out drawers (divided) 1 drop flap below (space divided) max. load up to 60 kg pre-assembled, 3 cases</p>	<p>W à 240 cm H 51 cm D 43 cm</p>
 <p>LHF RHF</p>					
order no.:	W200-..00L/R	order no.:	W202-..00	order no.:	W203-..00L/R
lacquerd	à	lacquerd		lacquerd	à

Finishes:

Please add the 5TH - 8TH number of the order-no. for the finish code.
(see overview page 2)

SIDEBORD X6

1 door
1 wood shelf, adjustable
2 full pull out drawers,
on top (divided)
1 drop flap (space divided)
assembled

W à 180 cm
H 70 cm
D 43 cm

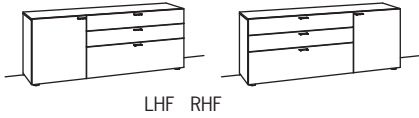

order no.: **W210-..00L/R**
lacquerd

SIDEBORD X6

2 doors
2 wood shelves, adjustable
3 full pull out drawers
assembled

W 180 cm
H 70 cm
D 43 cm



order no.: **W211-..00**
lacquerd

SIDEBORD X6

2 doors
2 wood shelves, adjustable
2 full pull out drawers,
on top (divided)
1 drop flap (space divided)
pre-assembled, 4 cases

W 240 cm
H 70 cm
D 43 cm



order no.: **W212-..00**
lacquerd

SIDEBORD X6

4 full pull out drawers
(divided)
2 drop flaps below
(spaces divided)
pre-assembled, 3 cases

W 240 cm
H 70 cm
D 43 cm



order no.: **W213-..00**
lacquerd

Finishes:

Please add the 5TH - 8TH number of the order-no. for the finish code.
(see overview page 2)

WALL PANEL WITH TRAYS X6

with 2 metal shelves:

Please add the
7th+8th no. of the order-no.
for the metal tray.
max. load up to 15 kg
pre-assembled, 2 cases

W 124 cm
H 85 cm
D 28 cm

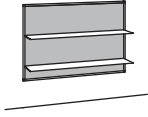

order no.:	W720-....	
-0311 oak rustico light oiled finish/crystal white		
-0318 oak rustico light oiled finish/anthracite		
-7211 wild oak light soft brushed. oiled finish/crystal white		
-7218 wild oak light soft brushed. oiled finish/anthracite		
rear panel lighting	W902-0012	
transformer	W915-0000	

HANGING CABINET X6

1 door
1 wood shelf, adjustable
max. load up to 30 kg
assembled

W à 64 cm
H 119 cm
D 33 cm

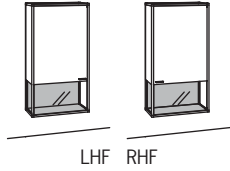

order no.: **W730-....L/R**

set of 1 LED lighting	W901-0001
rear panel lighting	W902-0002
transformer	W915-0000

HANGING CABINET X6

1 door
max. load up to 30 kg
assembled

W à 64 cm
H 119 cm
D 33 cm

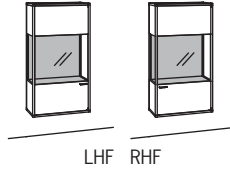

order no.: **W731-....L/R**

set of 1 LED lighting	W901-0001
rear panel lighting	W902-0002
transformer	W915-0000

HANGING CABINET X6

1 door
1 wood shelf, adjustable
max. load up to 30 kg
assembled

W à 64 cm
H 119 cm
D 33 cm

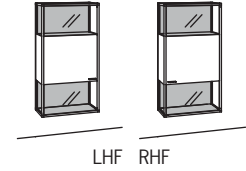

order no.: **W732-....L/R**

2x set of 1 LED lighting	W901-0001 à
rear panel lighting	W902-0004
transformer	W915-0000

HANGING CABINET X6

1 door
1 wood shelf, adjustable
2 open spaces
max. load up to 30 kg
assembled

W à 64 cm
H 119 cm
D 33 cm

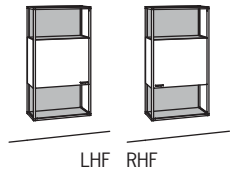

order no.: **W733-....L/R**

2x set of 1 LED lighting	W901-0001 à
rear panel lighting	W902-0004
transformer	W915-0000

HANGING CABINET X6

2 doors
2 wood shelves, adjustable
max. load up to 40 kg
assembled

W 124 cm
H 119 cm
D 33 cm



order no.: **W734-....**

2x set of 1 LED lighting	W901-0001 à
rear panel lighting	W902-0012
transformer	W915-0000

HANGING CABINET X6

2 doors
max. load up to 40 kg
assembled

W 124 cm
H 119 cm
D 33 cm

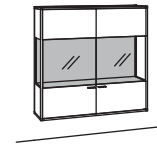

order no.: **W735-....**

2x set of 1 LED lighting	W901-0001 à
rear panel lighting	W902-0012
transformer	W915-0000

HANGING CABINET X6

2 doors
2 wood shelves, adjustable
max. load up to 40 kg
assembled

W 124 cm
H 119 cm
D 33 cm



order no.: **W736-....**

4x set of 1 LED lighting	W901-0001 à
rear panel lighting	W902-0014
transformer	W915-0000

HANGING CABINET X6

2 doors
2 wood shelves, adjustable
2 open spaces
max. load up to 40 kg
assembled

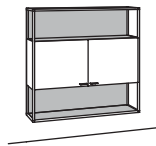

W 124 cm
H 119 cm
D 33 cm



order no.: **W737-....**

4x set of 1 LED lighting	W901-0001 à
rear panel lighting	W902-0014
transformer	W915-0000

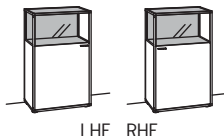
3 GRIDS H 104 cm **SIDEBOARD**

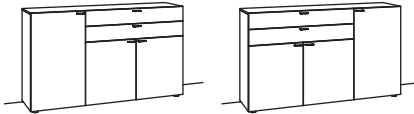
<p>SIDEBOARD X6</p> <p>1 door 1 wood shelf, adjustable assembled</p> <p>W à 64 cm H 104 cm D 43 cm</p>  <p>LHF RHF</p> <p>order no.: W300-....L/R à</p> <p>set of 1 LED lighting W901-0001 rear panel lighting W902-0002 transformer W915-0000</p>	<p>SIDEBOARD X6</p> <p>2 doors 2 wood shelves, adjustable assembled</p> <p>W 124 cm H 104 cm D 43 cm</p>  <p>order no.: W302-.... à</p> <p>2x set of 1 LED lighting W901-0001 à rear panel lighting W902-0012 transformer W915-0000</p>	<p>SIDEBOARD X6</p> <p>3 doors 4 wood shelves, adjustable 2 full pull out drawers (divided) pre-assembled, 3 cases</p> <p>W à 180 cm H 104 cm D 43 cm</p>  <p>order no.: W304-..00L/R à</p> <p>lacquerd</p>
---	--	---

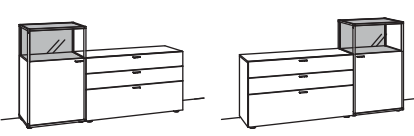
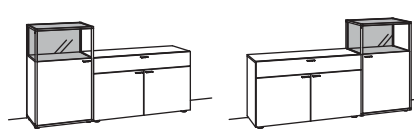
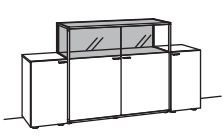
<p>SIDEBOARD X6</p> <p>1 door 1 wood shelf, adjustable 3 full pull out drawers (divided) pre-assembled, 2 cases</p> <p>W à 183 cm H 104 cm D 43 cm</p>  <p>order no.: W305-....L/R à</p> <p>set of 1 LED lighting W901-0001 rear panel lighting W902-0002 transformer W915-0000</p>	<p>SIDEBOARD X6</p> <p>3 doors 3 wood shelves, adjustable 1 full pull out drawers (divided) pre-assembled, 2 cases</p> <p>W à 183 cm H 104 cm D 43 cm</p>  <p>order no.: W306-....L/R à</p> <p>set of 1 LED lighting W901-0001 rear panel lighting W902-0002 transformer W915-0000</p>	<p>SIDEBOARD X6</p> <p>4 doors 4 wood shelves, adjustable pre-assembled, 3 cases</p> <p>W 203 cm H 104 cm D 43 cm</p>  <p>order no.: W308-.... à</p> <p>2x set of 1 LED lighting W901-0001 à rear panel lighting W902-0012 transformer W915-0000</p>
--	--	--

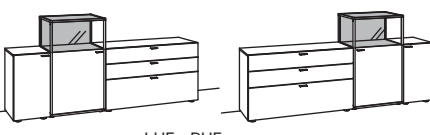
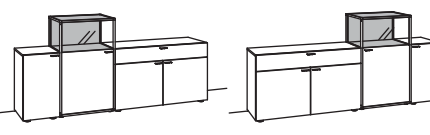
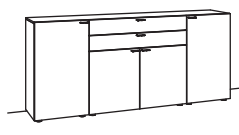
<p>SIDEBOARD X6</p> <p>2 doors 2 wood shelves, adjustable 3 full pull out drawers (divided) pre-assembled, 3 cases</p> <p>W à 223 cm H 104 cm D 43 cm</p>  <p>LHF RHF</p> <p>order no.: W310-....L/R à</p> <p>set of 1 LED lighting W901-0001 rear panel lighting W902-0002 transformer W915-0000</p>	<p>SIDEBOARD X6</p> <p>4 doors 4 wood shelves, adjustable 1 full pull out drawers (divided) pre-assembled, 3 cases</p> <p>W à 223 cm H 104 cm D 43 cm</p>  <p>order no.: W311-....L/R à</p> <p>set of 1 LED lighting W901-0001 rear panel lighting W902-0002 transformer W915-0000</p>	<p>SIDEBOARD X6</p> <p>4 doors 6 wood shelves, adjustable 2 full pull out drawers (divided) pre-assembled, 4 cases</p> <p>W 240 cm H 104 cm D 43 cm</p>  <p>order no.: W312-...00 à</p> <p>lacquerd</p>
---	--	---

Finishes:

Please add the 5TH - 8TH number of the order-no. for the finish code.
(see overview page 2)

3 GRIDS

H 104 cm

SIDEBOARD

SIDEBOARD X6

4 doors
4 wood shelves, adjustable
4 full pull out drawers
(divided)
pre-assembled, 3 cases

W 240 cm
H 104 cm
D 43 cm



order no.: **W313-..00**
lacquer

SIDEBOARD X6

3 doors
3 wood shelves, adjustable
3 full pull out drawers
pre-assembled, 3 cases

W à 243 cm
H 104 cm
D 43 cm

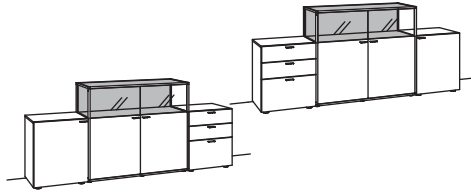

order no.: **W316-....L/R**

2x set of 1 LED lighting W901-0001 à
rear panel lighting W902-0012
transformer W915-0000

SIDEBOARD X6

2 doors
2 wood shelves, adjustable
3 full pull out drawers
(divided)
pre-assembled, 2 cases

W à 243 cm
H 104 cm
D 43 cm

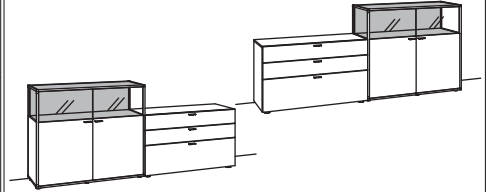

order no.: **W318-....LR**

2x set of 1 LED lighting W901-0001 à
rear panel lighting W902-0012
transformer W915-0000

SIDEBOARD X6

4 doors
4 wood shelves, adjustable
1 full pull out drawer
(divided)
pre-assembled, 2 cases

W à 243 cm
H 104 cm
D 43 cm

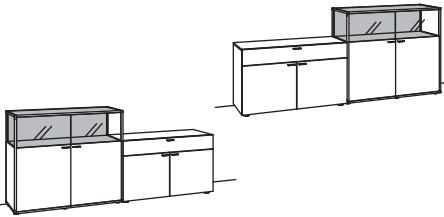

order no.: **W319-....L/R**

2x set of 1 LED lighting W901-0001 à
rear panel lighting W902-0012
transformer W915-0000

SIDEBOARD X6

3 doors
3 wood shelves, adjustable
3 full pull out drawers
(divided)
pre-assembled, 3 cases

W à 283 cm
H 104 cm
D 43 cm

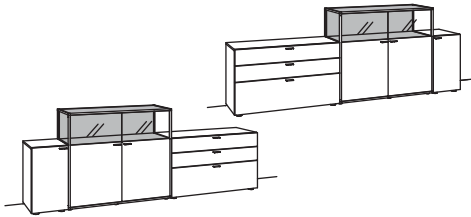

order no.: **W320-....L/R**

2x set of 1 LED lighting W901-0001 à
rear panel lighting W902-0012
transformer W915-0000

SIDEBOARD X6

5 doors
5 wood shelves, adjustable
1 full pull out drawer
(divided)
pre-assembled, 3 cases

W à 283 cm
H 104 cm
D 43 cm

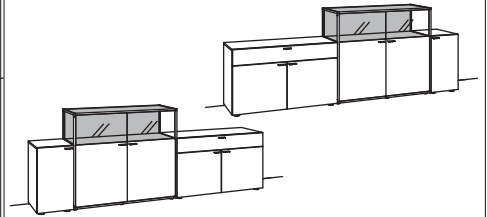

order no.: **W321-....L/R**

2x set of 1 LED lighting W901-0001 à
rear panel lighting W902-0012
transformer W915-0000

SIDEBOARD X6

3 doors
3 wood shelves, adjustable
3 full pull out drawers
(divided)
pre-assembled, 3 cases

W à 303 cm
H 104 cm
D 43 cm

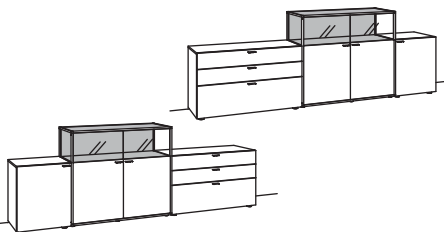

order no.: **W322-....L/R**

2x set of 1 LED lighting W901-0001 à
rear panel lighting W902-0012
transformer W915-0000

SIDEBOARD X6

5 doors
5 wood shelves, adjustable
1 full pull out drawer
(divided)
pre-assembled, 3 cases

W à 303 cm
H 104 cm
D 43 cm

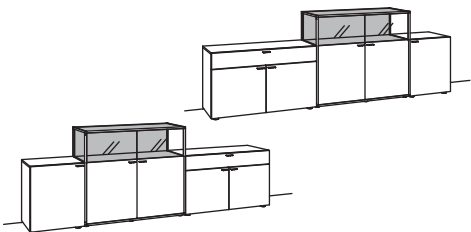

order no.: **W323-....L/R**

2x set of 1 LED lighting W901-0001 à
rear panel lighting W902-0012
transformer W915-0000

HIGHBOARD X6

1 door
1 wood shelf, adjustable
assembled

W à 64 cm
H 138 cm
D 43 cm

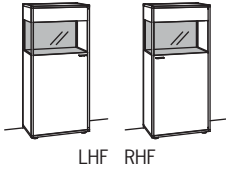

LHF RHF

order no.: **W400-....L/R**

set of 1 LED lighting	W901-0001
rear panel lighting	W902-0002
transformer	W915-0000

HIGHBOARD X6

1 door
2 wood shelves, adjustable
assembled

W à 64 cm
H 138 cm
D 43 cm

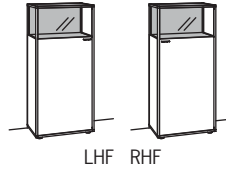

LHF RHF

order no.: **W401-....L/R**

set of 1 LED lighting	W901-0001
rear panel lighting	W902-0002
transformer	W915-0000

HIGHBOARD X6

1 door
1 wood shelf, adjustable
assembled

W à 64 cm
H 137 cm
D 43 cm

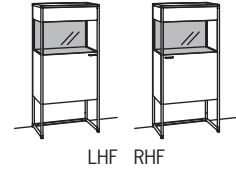

LHF RHF

order no.: **W402-....L/R**

set of 1 LED lighting	W901-0001
rear panel lighting	W902-0002
transformer	W915-0000

HIGHBOARD X6

1 door
1 wood shelf, adjustable
1 open space
assembled

W à 64 cm
H 137 cm
D 43 cm

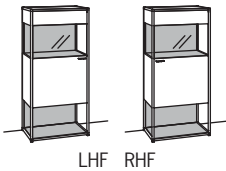

LHF RHF

order no.: **W441-....L/R**

2x set of 1 LED lighting	W901-0001 à
rear panel lighting	W902-0004
transformer	W915-0000

HIGHBOARD X6

1 door
1 full pull out drawer
assembled

W à 64 cm
H 137 cm
D 43 cm

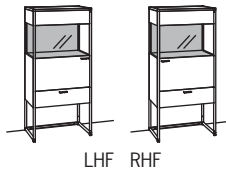

LHF RHF

order no.: **W403-....L/R**

set of 1 LED lighting	W901-0001
rear panel lighting	W902-0002
transformer	W915-0000

HIGHBOARD X6

1 door
1 full pull out drawer
1 open space
assembled

W à 64 cm
H 137 cm
D 43 cm

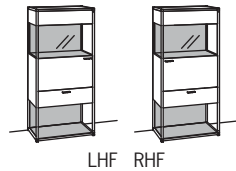

LHF RHF

order no.: **W405-....L/R**

2x set of 1 LED lighting	W901-0001 à
rear panel lighting	W902-0004
transformer	W915-0000

HIGHBOARD X6

1 door
1 wood shelf, adjustable
assembled

W à 64 cm
H 137 cm
D 43 cm

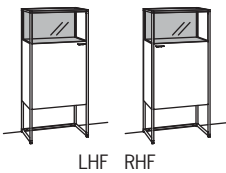

LHF RHF

order no.: **W404-....L/R**

set of 1 LED lighting	W901-0001
rear panel lighting	W902-0002
transformer	W915-0000

HIGHBOARD X6

1 door
1 wood shelf, adjustable
1 open space
assembled

W à 64 cm
H 137 cm
D 43 cm

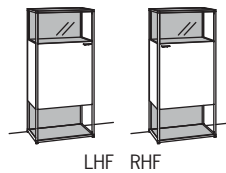

LHF RHF

order no.: **W406-....L/R**

2x set of 1 LED lighting	W901-0001 à
rear panel lighting	W902-0004
transformer	W915-0000

HIGHBOARD X6

2 doors
2 wood shelves, adjustable
assembled

W 124 cm
H 138 cm
D 43 cm



order no.: **W407-....**

2x set of 1 LED lighting	W901-0001 à
rear panel lighting	W902-0012
transformer	W915-0000

HIGHBOARD X6

2 doors
1 wood shelf, adjustable
3 full pull out drawers
assembled

W à 124 cm
H 138 cm
D 43 cm



order no.: **W408-....L/R**

HIGHBOARD X6

2 doors
4 wood shelves, adjustable
assembled

W 124 cm
H 138 cm
D 43 cm



order no.: **W409-....**

HIGHBOARD X6

2 doors
2 wood shelves, adjustable
assembled

W 124 cm
H 137 cm
D 43 cm



order no.: **W410-....**

2x set of 1 LED lighting W901-0001 à
rear panel lighting W902-0012
transformer W915-0000

2x set of 1 LED lighting W901-0001 à
rear panel lighting W902-0012
transformer W915-0000

2x set of 1 LED lighting W901-0001 à
rear panel lighting W902-0012
transformer W915-0000

HIGHBOARD X6

2 doors
2 wood shelves, adjustable
1 open space
assembled

W 124 cm
H 137 cm
D 43 cm



order no.: **W444-....**

HIGHBOARD X6

2 doors
1 full pull out drawer
(divided)
assembled

W 124 cm
H 137 cm
D 43 cm



order no.: **W411-....**

HIGHBOARD X6

2 doors
1 full pull out drawer
(divided)
1 open space
assembled

W 124 cm
H 137 cm
D 43 cm



order no.: **W415-....**

4x set of 1 LED lighting W901-0001 à
rear panel lighting W902-0014
transformer W915-0000

2x set of 1 LED lighting W901-0001 à
rear panel lighting W902-0012
transformer W915-0000

4x set of 1 LED lighting W901-0001 à
rear panel lighting W902-0014
transformer W915-0000

HIGHBOARD X6

2 doors
2 wood shelves, adjustable
assembled

W 124 cm
H 137 cm
D 43 cm



order no.: **W412-....**

HIGHBOARD X6

2 doors
2 wood shelves, adjustable
1 open space
assembled

W 124 cm
H 137 cm
D 43 cm



order no.: **W416-....**

HIGHBOARD X6

2 doors
2 wood shelves, adjustable
2 full pull out drawers
(divided)
pre-assembled, 3 cases

W à 223 cm
H 137 cm
D 43 cm

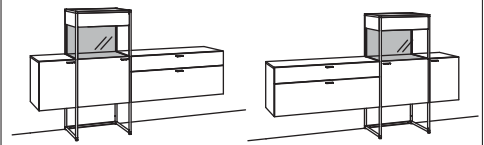

order no.: **W417-....L/R**

2x set of 1 LED lighting W901-0001 à
rear panel lighting W902-0012
transformer W915-0000

4x set of 1 LED lighting W901-0001 à
rear panel lighting W902-0014
transformer W915-0000

set of 1 LED lighting W901-0001
rear panel lighting W902-0002
transformer W915-0000

HIGHBOARD X6

2 doors
2 wood shelves, adjustable
2 full pull out drawers
(divided)
1 open space
pre-assembled, 3 cases

W à 223 cm
H 137 cm
D 43 cm

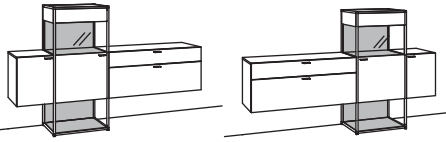

order no.: **W442-....L/R** à

2x set of 1 LED lighting W901-0001 à
rear panel lighting W902-0004
transformer W915-0000

HIGHBOARD X6

2 doors
2 wood shelves, adjustable
3 full pull out drawers
(divided)
pre-assembled, 3 cases

W à 223 cm
H 137 cm
D 43 cm

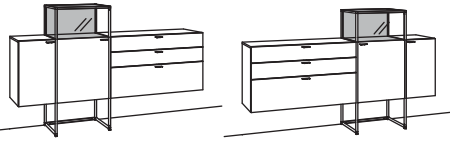

order no.: **W418-....L/R** à

set of 1 LED lighting W901-0001
rear panel lighting W902-0002
transformer W915-0000

HIGHBOARD X6

2 doors
2 wood shelves, adjustable
3 full pull out drawers
(divided)
1 open space
pre-assembled, 3 cases

W à 223 cm
H 137 cm
D 43 cm

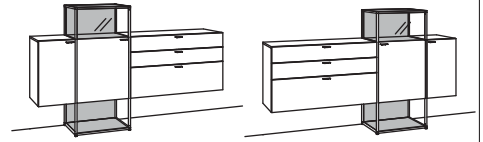

order no.: **W419-....L/R** à

2x set of 1 LED lighting W901-0001 à
rear panel lighting W902-0004
transformer W915-0000

HIGHBOARD X6

4 doors
6 wood shelves, adjustable
2 full pull out drawers
(divided)
pre-assembled, 3 cases

W à 243 cm
H 138 cm
D 43 cm

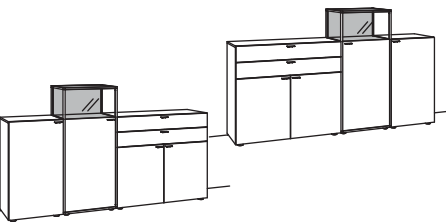

order no.: **W420-....L/R** à

set of 1 LED lighting W901-0001
rear panel lighting W902-0002
transformer W915-0000

HIGHBOARD X6

1 door
1 wood shelf, adjustable
4 full pull out drawers
(the two large drawers are divided)
pre-assembled, 3 cases

W à 243 cm
H 137 cm
D 43 cm

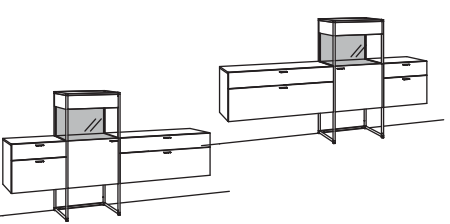

LHF RHF

order no.: **W421-....L/R** à

set of 1 LED lighting W901-0001
rear panel lighting W902-0002
transformer W915-0000

HIGHBOARD X6

1 door
1 wood shelf, adjustable
4 full pull out drawers
(the two large drawers are divided)
1 open space
pre-assembled, 3 cases

W à 243 cm
H 137 cm
D 43 cm

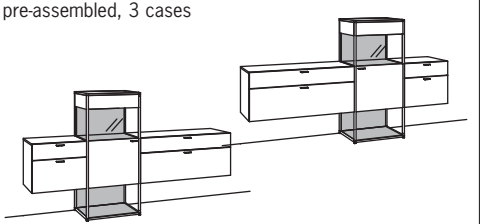

LHF RHF

order no.: **W443-....L/R** à

2x set of 1 LED lighting W901-0001 à
rear panel lighting W902-0004
transformer W915-0000

HIGHBOARD X6

2 doors
2 wood shelves, adjustable
3 full pull out drawers
(divided)
pre-assembled, 3 cases

W à 243 cm
H 137 cm
D 43 cm

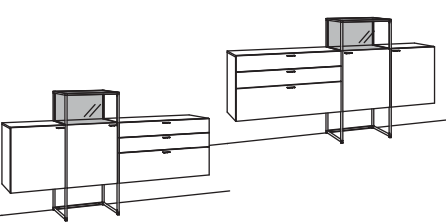

order no.: **W422-....L/R** à

set of 1 LED lighting W901-0001
rear panel lighting W902-0002
transformer W915-0000

HIGHBOARD X6

2 doors
2 wood shelves, adjustable
3 full pull out drawers
(divided)
1 open space
pre-assembled, 3 cases

W à 243 cm
H 137 cm
D 43 cm

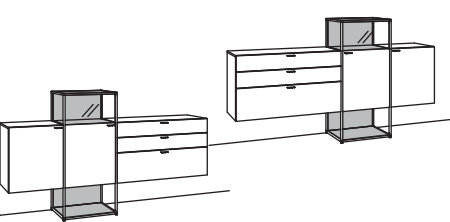

order no.: **W423-....L/R** à

2x set of 1 LED lighting W901-0001 à
rear panel lighting W902-0004
transformer W915-0000

HIGHBOARD X6

4 doors
6 wood shelves, adjustable
4 full pull out drawers
pre-assembled, 3 cases

W 243 cm
H 138 cm
D 43 cm



order no.: **W424-....**

2x set of 1 LED lighting W901-0001 à
rear panel lighting W902-0012
transformer W915-0000

Finishes:

Please add the 5TH - 8TH number of the order-no. for the finish code.
(see overview page 2)

4 GRIDS

H 137/138 cm

HIGHBOARD

HIGHBOARD X6

2 doors
2 wood shelves, adjustable
4 full pull out drawers
pre-assembled, 3 cases

W 243 cm
H 137 cm
D 43 cm



order no.: **W425-....**

2x set of 1 LED lighting W901-0001 à
rear panel lighting W902-0012
transformer W915-0000

HIGHBOARD X6

2 doors
2 wood shelves, adjustable
4 full pull out drawers
1 open space
pre-assembled, 3 cases

W 243 cm
H 137 cm
D 43 cm



order no.: **W445-....**

4x set of 1 LED lighting W901-0001 à
rear panel lighting W902-0014
transformer W915-0000

HIGHBOARD X6

2 doors
5 full pull out drawers
(the large drawer is divided)
pre-assembled, 3 cases

W 243 cm
H 137 cm
D 43 cm



order no.: **W426-....**

2x set of 1 LED lighting W901-0001 à
rear panel lighting W902-0012
transformer W915-0000

HIGHBOARD X6

2 doors
5 full pull out drawers
(the large drawer is divided)
1 open space
pre-assembled, 3 cases

W 243 cm
H 137 cm
D 43 cm



order no.: **W428-....**

4x set of 1 LED lighting W901-0001 à
rear panel lighting W902-0014
transformer W915-0000

HIGHBOARD X6

2 doors
2 wood shelves, adjustable
6 full pull out drawers
pre-assembled, 3 cases

W 243 cm
H 137 cm
D 43 cm



order no.: **W427-....**

2x set of 1 LED lighting W901-0001 à
rear panel lighting W902-0012
transformer W915-0000

HIGHBOARD X6

2 doors
2 wood shelves, adjustable
6 full pull out drawers
1 open space
pre-assembled, 3 cases

W 243 cm
H 137 cm
D 43 cm



order no.: **W429-....**

4x set of 1 LED lighting W901-0001 à
rear panel lighting W902-0014
transformer W915-0000

HIGHBOARD X6

3 doors
3 wood shelves, adjustable
1 full pull out drawer,
on top (divided)
1 drop flap (space divided)
pre-assembled, 3 cases

W à 283 cm
H 137 cm
D 43 cm



order no.: **W430-....L/R**

2x set of 1 LED lighting W901-0001 à
rear panel lighting W902-0012
transformer W915-0000

HIGHBOARD X6

3 doors
3 wood shelves, adjustable
1 full pull out drawer,
on top (divided)
1 drop flap (space divided)
1 open space
pre-assembled, 3 cases

W à 283 cm
H 137 cm
D 43 cm

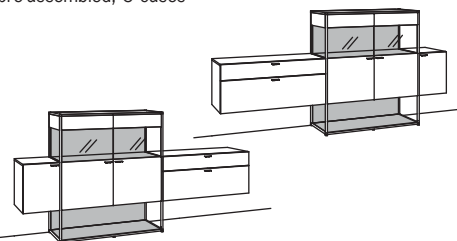

order no.: **W446-....L/R**

4x set of 1 LED lighting W901-0001 à
rear panel lighting W902-0014
transformer W915-0000

HIGHBOARD X6

3 doors
1 wood shelf, adjustable
2 full pull out drawers
below (divided)
1 drop flap (space divided)
pre-assembled, 3 cases

W à 283 cm
H 137 cm
D 43 cm

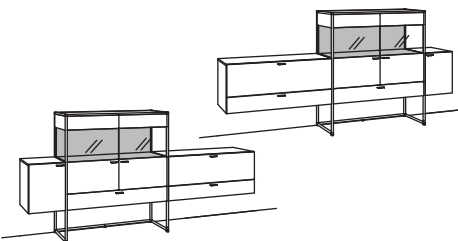

order no.: **W431-....L/R**

2x set of 1 LED lighting W901-0001 à
rear panel lighting W902-0012
transformer W915-0000

Finishes:

Please add the 5TH - 8TH number of the order-no. for the finish code.
(see overview page 2)

4 GRIDS

H 137/138 cm

HIGHBOARD

HIGHBOARD X6

3 doors
1 wood shelf, adjustable
2 full pull out drawers
(divided)
1 drop flap on top (space divided)
1 open space
pre-assembled, 3 cases

W à 283 cm
H 137 cm
D 43 cm

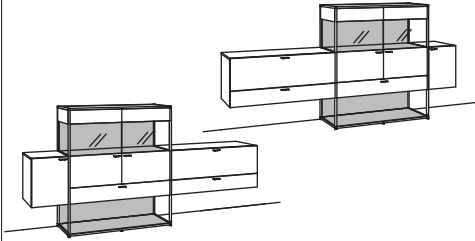

order no.: **W433-....L/R**

4x set of 1 LED lighting W901-0001 à
rear panel lighting W902-0014
transformer W915-0000

HIGHBOARD X6

3 doors
3 wood shelves, adjustable
2 full pull out drawers
on top (divided)
1 drop flap (space divided)
pre-assembled, 3 cases

W à 283 cm
H 137 cm
D 43 cm

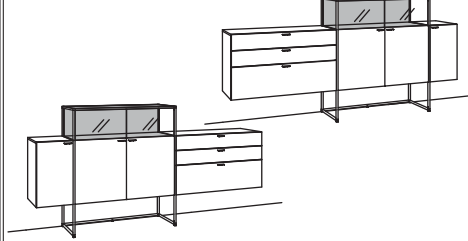

order no.: **W432-....L/R**

2x set of 1 LED lighting W901-0001 à
rear panel lighting W902-0012
transformer W915-0000

HIGHBOARD X6

3 doors
3 wood shelves, adjustable
2 full pull out drawers
on top (divided)
1 drop flap (space divided)
1 open space
pre-assembled, 3 cases

W à 283 cm
H 137 cm
D 43 cm

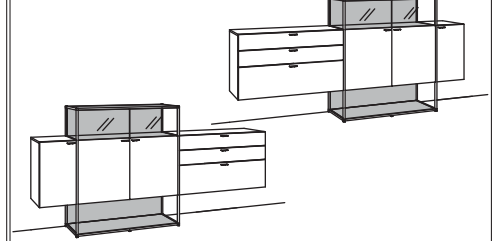

order no.: **W434-....L/R**

4x set of 1 LED lighting W901-0001 à
rear panel lighting W902-0014
transformer W915-0000

HIGHBOARD X6

5 doors
7 wood shelves, adjustable
4 full pull out drawers
(the two large drawers are
divided)
pre-assembled, 3 cases

W à 303 cm
H 138 cm
D 43 cm

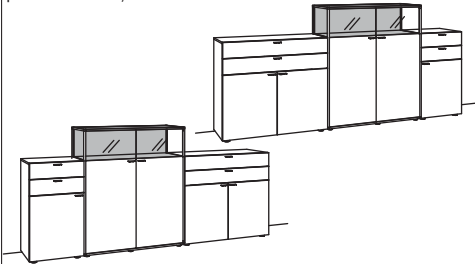

order no.: **W435-....L/R**

2x set of 1 LED lighting W901-0001 à
rear panel lighting W902-0012
transformer W915-0000

HIGHBOARD X6

3 doors
3 wood shelves, adjustable
1 full pull out drawer,
on top (divided)
1 drop flap (space divided)
pre-assembled, 3 cases

W à 303 cm
H 137 cm
D 43 cm

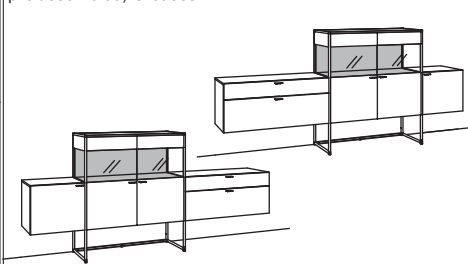

order no.: **W436-....L/R**

2x set of 1 LED lighting W901-0001 à
rear panel lighting W902-0012
transformer W915-0000

HIGHBOARD X6

3 doors
3 wood shelves, adjustable
1 full pull out drawer,
on top (divided)
1 drop flap (space divided)
1 open space
pre-assembled, 3 cases

W à 303 cm
H 137 cm
D 43 cm

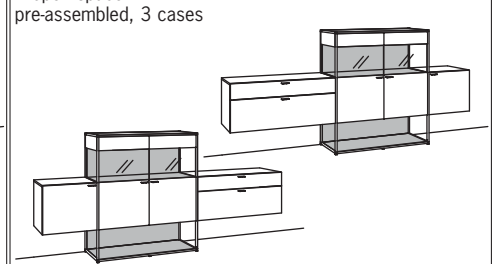

order no.: **W447-....L/R**

4x set of 1 LED lighting W901-0001 à
rear panel lighting W902-0014
transformer W915-0000

HIGHBOARD X6

3 doors
1 wood shelf, adjustable
2 full pull out drawers
(divided)
1 drop flap on top (space divided)
pre-assembled, 3 cases

W à 303 cm
H 137 cm
D 43 cm

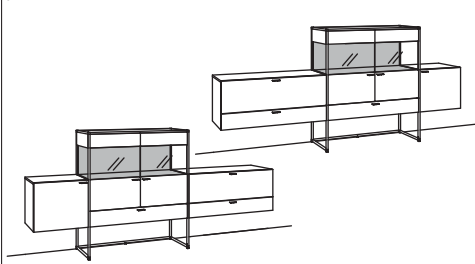

order no.: **W437-....L/R**

2x set of 1 LED lighting W901-0001 à
rear panel lighting W902-0012
transformer W915-0000

HIGHBOARD X6

3 doors
1 wood shelf, adjustable
2 full pull out drawers
(divided)
1 drop flap on top (space divided)
1 open space
pre-assembled, 3 cases

W à 303 cm
H 137 cm
D 43 cm

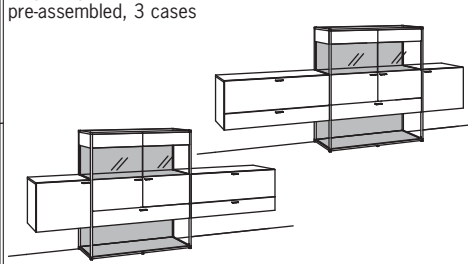

order no.: **W439-....L/R**

4x set of 1 LED lighting W901-0001 à
rear panel lighting W902-0014
transformer W915-0000

HIGHBOARD X6

3 doors
3 wood shelves, adjustable
2 full pull out drawers
on top (divided)
1 drop flap (space divided)
pre-assembled, 3 cases

W à 303 cm
H 137 cm
D 43 cm

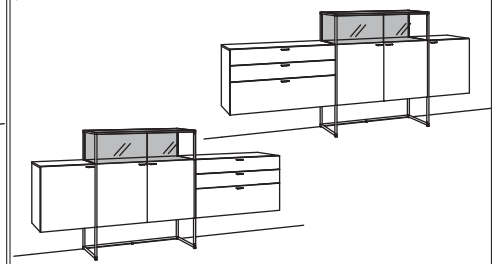

order no.: **W438-....L/R**

2x set of 1 LED lighting W901-0001 à
rear panel lighting W902-0012
transformer W915-0000

Finishes:

Please add the 5TH - 8TH number of the order-no. for the finish code.
(see overview page 2)

HIGHBOARD X6

- 3 doors
- 3 wood shelves, adjustable
- 2 full pull out drawers, on top (divided)
- 1 drop flap (space divided)
- 1 open space
- pre-assembled, 3 cases

W à 303 cm
H 137 cm
D 43 cm

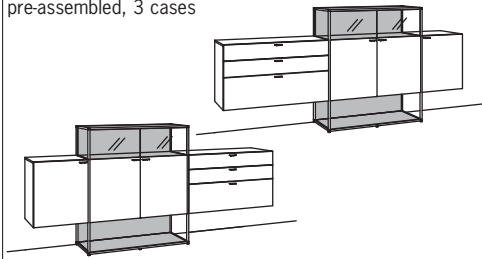

order no.:	W440-....L/R	à
4x set of 1 LED lighting	W901-0001 à	
rear panel lighting	W902-0014	
transformer	W915-0000	

Finishes:

Please add the 5TH - 8TH number of the order-no. for the finish code.
(see overview page 2)

6 GRIDS

H 205/206 cm

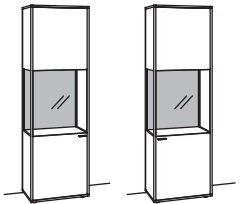
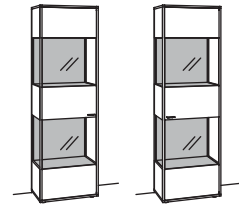
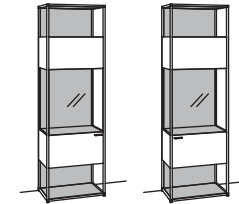

CABINET

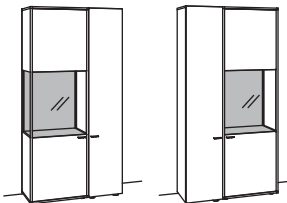
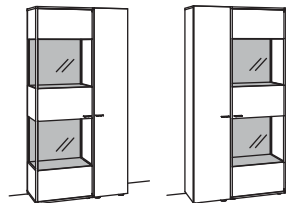
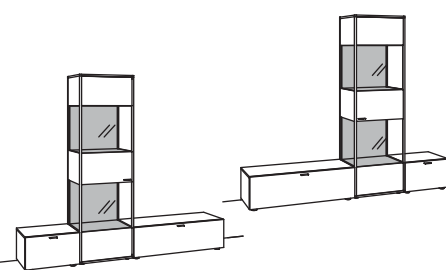

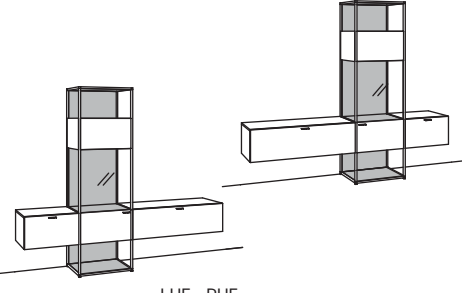
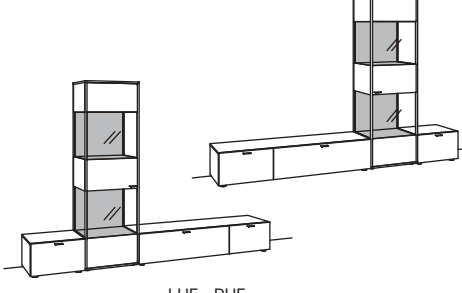
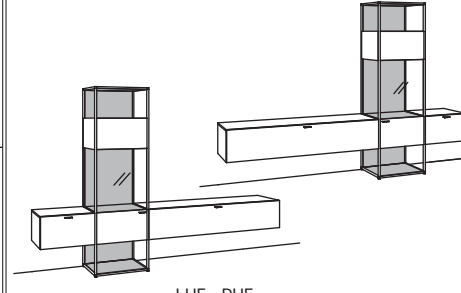
CABINET X6		CABINET X6		CABINET X6	
1 door 2 wood shelves, adjustable assembled	W à 64 cm H 206 cm D 43 cm	1 door assembled	W à 64 cm H 206 cm D 43 cm	1 door 2 open spaces assembled	W à 64 cm H 205 cm D 43 cm
					
LHF RHF		LHF RHF		LHF RHF	
order no.: W600-....L/R	à	order no.: W601-....L/R	à	order no.: W602-....L/R	à
set of 1 LED lighting rear panel lighting transformer	W901-0001 W902-0002 W915-0000	2x set of 1 LED lighting rear panel lighting transformer	W901-0001 à W902-0004 W915-0000	3x set of 1 LED lighting rear panel lighting transformer	W901-0001 à W902-0006 W915-0000



CABINET X6		CABINET X6		CABINET RECOMMENDATION X6	
2 doors 6 wood shelves, adjustable 1 fixed shelf pre-assembled, 2 cases	W à 104 cm H 206 cm D 43 cm	2 doors 4 wood shelves, adjustable 1 fixed shelf pre-assembled, 2 cases	W à 104 cm H 206 cm D 43 cm	1 door 1 full pull out drawer 1 drop flap (space divided) pre-assembled, 3 cases	W à 243 cm H 206 cm D 43 cm
					
LHF RHF		LHF RHF		LHF RHF	
order no.: W603-....L/R	à	order no.: W604-....L/R	à	order no.: W605-....L/R	à
set of 1 LED lighting rear panel lighting transformer	W901-0001 W902-0002 W915-0000	2x set of 1 LED lighting rear panel lighting transformer	W901-0001 à W902-0004 W915-0000	2x set of 1 LED lighting rear panel lighting transformer cable outlet	W901-0001 à W902-0004 W915-0000 W840-0000

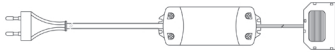

CABINET RECOMMENDATION X6		CABINET RECOMMENDATION X6		CABINET RECOMMENDATION X6	
1 door 1 full pull out drawer 1 drop flap (space divided) 2 open spaces pre-assembled, 3 cases	W à 243 cm H 205 cm D 43 cm	1 door 2 full pull out drawers 1 drop flap (space divided) pre-assembled, 3 cases	W à 303 cm H 206 cm D 43 cm	1 door 1 full pull out drawer 1 drop flap (space tri-parted) 2 open spaces pre-assembled, 3 cases	W à 303 cm H 205 cm D 43 cm
					
LHF RHF		LHF RHF		LHF RHF	
order no.: W606-....L/R	à	order no.: W607-....L/R	à	order no.: W608-....L/R	à
3x set of 1 LED lighting rear panel lighting 2x transformer cable outlet	W901-0001 à W902-0006 W915-0000 à W840-0000	2x set of 1 LED lighting rear panel lighting transformer cable outlet	W901-0001 à W902-0004 W915-0000 W840-0000	3x set of 1 LED lighting rear panel lighting 2x transformer cable outlet	W901-0001 à W902-0006 W915-0000 à W840-0000

SUPPLEMENTARY EQUIPMENT

WOOD SHELF X6 (ADDITIONAL)		WOOD SHELF X6 (ADDITIONAL)		WOOD SHELF X6 (ADDITIONAL)	
behind 40 cm door for lowboards, sideboards, highboards and cabinets	W 36,5 cm H 1,6 cm D 36 cm	behind 60 cm door for lowboards, sideboards, highboards and cabinets	W 56,5 cm H 1,6 cm D 36 cm	behind 60 cm door for hanging cabinets	W 56,5 cm H 1,6 cm D 26 cm
					
order no.: W890-..00		order no.: W891-..00		order no.: W892-..00	
-3700 lacquered crystal white matt		-3700 lacquered crystal white matt		-3700 lacquered crystal white matt	
-3800 lacquered anthracite matt		-3800 lacquered anthracite matt		-3800 lacquered anthracite matt	

LED LIGHTING X6 FOR SPACE		LED REAR PANEL LIGHTING X6		TRANSFORMER X6	
set of 1 LED lighting 1 x 1,2 watt = 1,2 watt connecting line 0,25 m per light not possible to retrofit!		LED flex tape wattage see below		LED converter 2-30 watt power cord 1,5 m extension cord for 6 LED lightings 0,1 m incl. Touch-Light	
for assignment see order no.		When ordering lightings for your furniture please add the right amount of transformers!		Max. load of the transformer is 30 watt. Please add up the wattage for each lighting and order the needed number of transformers!	
					
order no.: W901-0001		order no.: W902-00..		order no.: W915-0000	
transformer W915-0000		-0002 for W 64 cm / 2x, 12 watt -0004 for W 64 cm / 4x, 23 watt -0006 for W 64 cm / 6x, 35 watt -0011 for W 124 cm / 1x, 12 watt -0012 for W 124 cm / 2x, 23 watt -0014 for W 124 cm / 4x, 46 watt			
		transformer W915-0000			

EXTRA EXTENSION CORD X6		TRANSMIT DIMMER SET		CUTLERY INSERT X6	
extension cord for 6 LED lights 2 meters		control of lighting (transmit dimmer) as an alternative to handling the LED via Touch-Light. There are 3 possible lighting arrangements that can be used, programmed and saved. It is also possible to dim the different lighting arrangements separately. Max. current 3 x 30 watt.		plastic for 60 cm drawers	
					
order no.: W916-0000		order no.: 0094-0043		order no.: W847-0000	

CABLE OUTLET IN TOP PANEL X6		CABLE OUTLET IN STACKING UNIT X6	
The cable outlet is always positioned in the centre of the top panel of the item or centered under the stacked element if preferred at a different position please indicate.		The cable outlet is always positioned in the centre of the stacked element if preferred at a different position please indicate.	
			
order no.: W840-0000		order no.: W841-0000	